

T032NSL930CADB | RAY 115

Professional adjustable LED projector

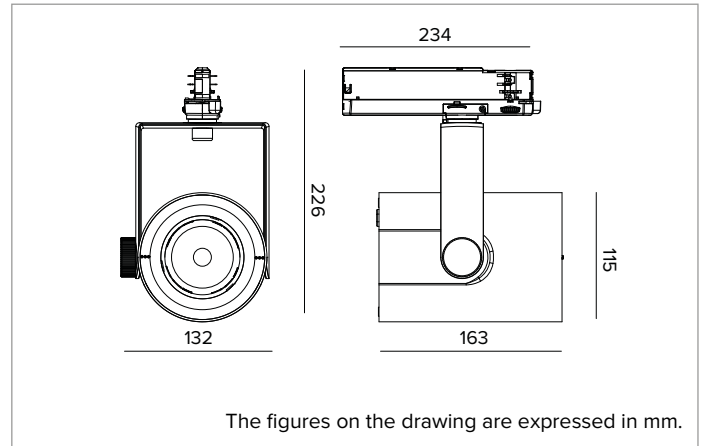

	3000K	H(m)	D(m)	E _{max} (lx)
	Ra90		9°	
Fixture Power	22W	1	0.17	47331
Source Flux	1954lm	2	0.33	11833
Fixture Flux	1605lm	3	0.50	5259
Efficacy	72lm/W	4	0.66	2958
TS1909 I _{max} =24222cd/klm	I _{max} 47331cd	5	0.83	1893



SOURCE

High efficiency Chip on Board LED Ra90. Ra97 on request.

Energy efficiency class: F

Nominal power: 19W

Nominal flux: 1954lm

Colour rendering index: 90

Rf: 92

Rg: 101

CCT nominal: 3000K

Lifetime (L80/B10): >50000h tq +25°C

ILLUMINOTECHNICAL CHARACTERISTICS

Optical grade PMMA TIR lens. Interchangeable lenses available as accessories (excluding the Narrow Spot optic).

Optic: LENS

Beam angles: NSP

Optical efficiency: 82%

Fixture flux: 1605lm

Luminous efficacy: 72lm/W

Photobiological safety: Compliant with RG1 low risk group

MECHANICAL CHARACTERISTICS

Painted die-cast aluminium body. Black painted polycarbonate front ring. Adjustable from 0° to -90° on the vertical plane and 359° on the horizontal plane. Mechanical beam locking system on the vertical plane and friction beam locking system on the horizontal plane. The centre of gravity always remains in axis with the track regardless of the aiming.

Colour and finish: Deep black

Dimensions: 115

Weight: 1.2Kg

Degree of protection: IP20

ELECTRICAL CHARACTERISTICS

CASAMBI electronic driver integrated into the track adapter.

Fixture Power: 22W

Power supply: 220-240Vac 50/60Hz

Insulation Class: CLASS 2

Type of driver / Control: CASAMBI

Driver included: YES

Class F: YES

SAFE FLICKER: PstLM=<1 and SVM=<0.4 (IEC TR 61547-1 and IEC TR 63158), to ensure a more comfortable and safe light

Ambient temperature: 0°C / +25°C

INSTALLATION

Electrified track mounting. Optical accessories that can be installed with a support ring are available.

NOTES

Commissioning of the control system via free APP; the intervention of a specialist technician can be quoted on request.

WARRANTY

5 years.

WARNING

Luminaire designed for disposal/recycling at end-of-life. Replaceable (LED only) light source by a professional. Replaceable control gear by a professional.

Due to the technological evolution of the electronic components, the data provided may be updated, and as such, confirmation must be requested during the order process.

Luminous flux and power supply have +/-10% tolerances with respect to the indicated value. tq +25°C (CIE 121).

We reserve the right to make technical changes.

Targetti Sankey S.r.l.
Via Pratese, 164
50145 Firenze - Italy
Tel: +39 055 37911
targetti.com
targetti@targetti.com

CCIAA Firenze
Share Capital:
€ 500.000,00
VAT N. (IT):
01537660480
R.E.A: FI-275656

TARGETTI

T032NSL930CADB | RAY 115
Professional adjustable LED projector

Accessories

Screen



Colour	Code
●	A079

Black polycarbonate accessory holder ring.



Ø mm	Code
80	1T3143

Black painted anodized diffusive aluminium asymmetric screen.
Complete with blade light filter.
Ideal for a Wall Washer effect.
To be combined with spot and flood optics.
For RAY 115 versions with lens.

Grid



Ø mm	Code
70	1T1711

Anti-glare louver.
Black painted metal honeycomb structure.
To be completed with a dedicated holder ring A079.
For RAY 115 versions with lens.

Filter



Ø mm	Code
70	1T1708

Flat striped glass blade light refractive filter.
This makes the beam take on an oval shape and when combined with spotlights, the light blade appears more prominent.
To be completed with a dedicated holder ring A079.
For RAY 115 versions with lens.

Cut-off



Ø mm	Code
80	1T3142

Cut-off Tube.
Allows for the beam to be focused while removing the fall-off component.

Ray Shade



Ø mm	Code
118	A025

Adjustable barn doors flaps made of black painted steel.

Due to the technological evolution of the electronic components, the data provided may be updated, and as such, confirmation must be requested during the order process.
Luminous flux and power supply have +/-10% tolerances with respect to the indicated value. tq +25°C (CIE 121).

We reserve the right to make technical changes.

Targetti Sankey S.r.l.
Via Pratese, 164
50145 Firenze - Italy
Tel: +39 055 37911
targetti.com
targetti@targetti.com

CCIAA Firenze
Share Capital:
€ 500.000,00
VAT N. (IT):
01537660480
R.E.A: FI-275656

